

23-7.3EG-L9

Single Lever Extended Gooseneck Monoblock
Flow Rate: 1.75 GPM

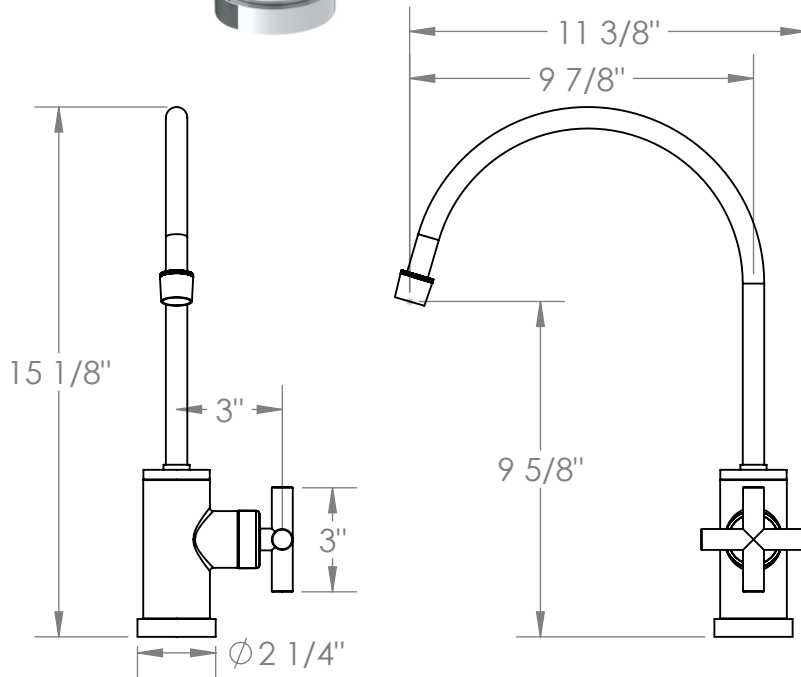

Meets the applicable requirements of ASME A112.18.1-2005/CSA B125.1-05, entitled "Plumbing Supply Fittings"